

A long, well-lit stable aisle with wooden stalls and metal railings. The stalls have a wooden lower half with a diagonal brace and a metal upper half with vertical bars. The ceiling is high with wooden beams and skylights. The floor is made of grey tiles.

Smulderz

The Dutch Heritage Since 1997

SOME HORSES
HAVE ALL THE LUCK !!

11 edition

contents

- 3. ABOUT US
- 4. OUR PRODUCTION
- 7. INTERNAL STABLES
- 53. PARTITION WALLS
- 57. OUTDOOR STABLES
- 59. AMERICAN BARNS
- 61. WINDOWS
- 67. DOORS
- 73. BARN DOORS
- 81. HORSE SOLARIUMS
- 85. ACCESSORIES
- 87. HORSE WALKERS AND ROOFINGS



About us

NL

Smulders staat al twintig jaar garant voor hoogwaardige producten voor de paardenmarkt. Alles wordt in eigen huis ontwikkeld en geproduceerd en dit doen we voor een zeer concurrerende prijs.

GB

With over twenty years' experience in the industry, we are capable of producing high quality products for the equine market at very competitive prices.

ES

Con más de 20 años de experiencia en la industria, somos capaces de fabricar productos de gran calidad para el mercado equino a precios muy competitivos.

The Dutch Heritage Since 1997

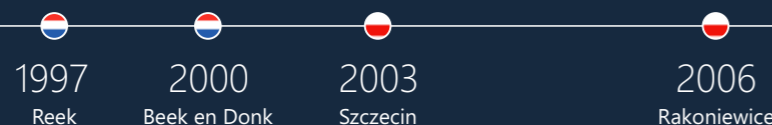

"It will always be possible to build a better stable"

Edzeek Smulders

Project, production and montage

Our production operatives are well qualified and experienced in steel fabrication both mild and stainless.

We have our own in-house technical and creative department with all of the latest computer-aided drawing technologies.

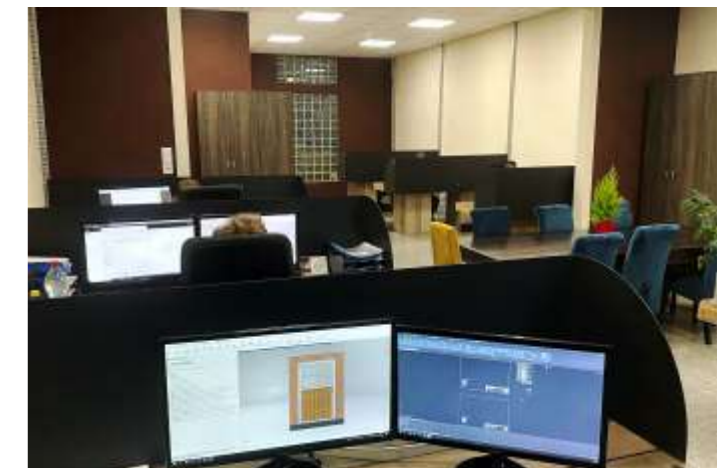

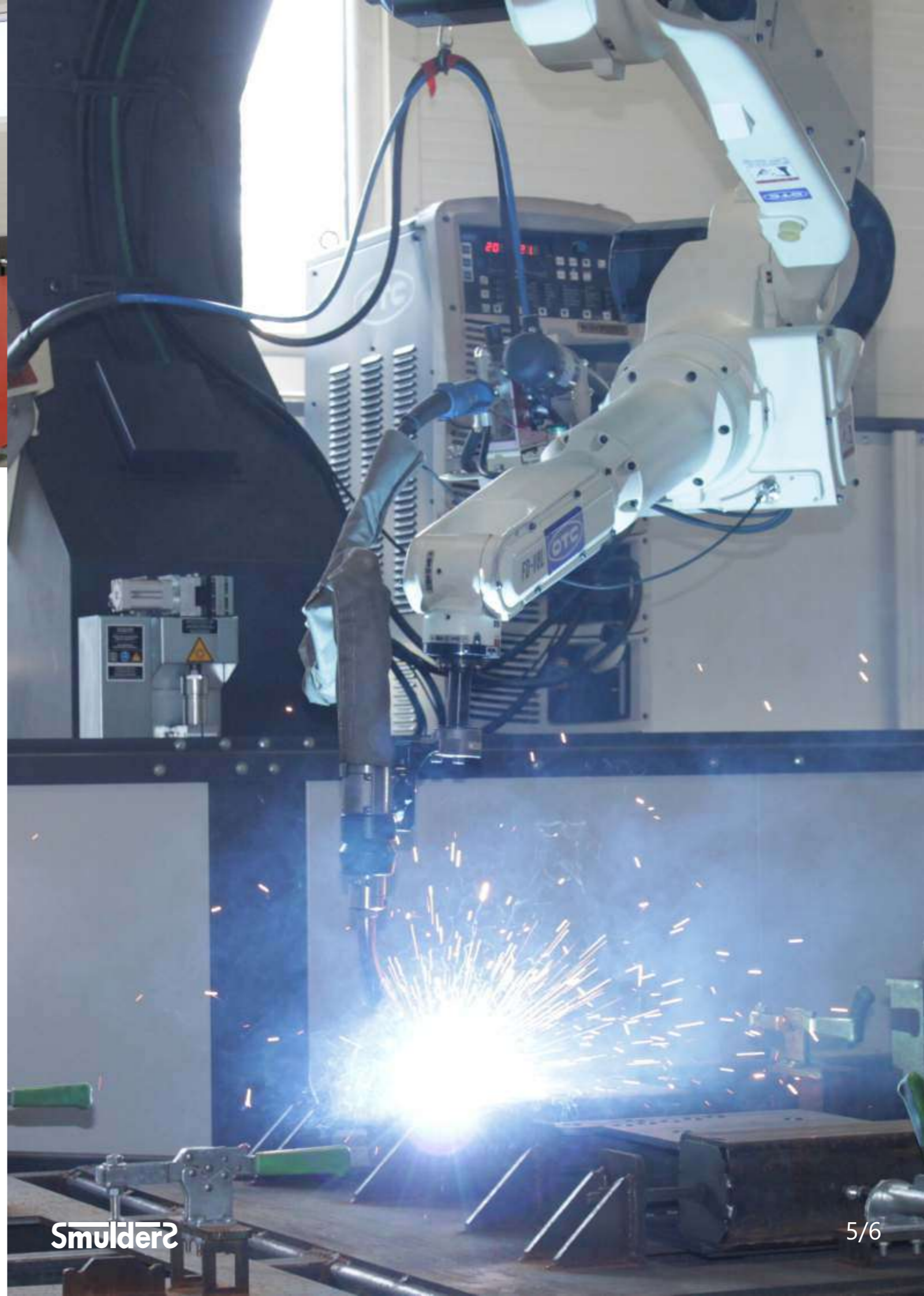

Our machine park

Modern state of the art production machines ensure accuracy and efficiency of manufacture.



THE VERY POPULAR SERIES

Sport-Line

NL Deze erg populaire serie wordt al jaren goed ontvangen zowel bij particulieren als bij professionals.

GB This very popular series is well received by both private individuals and professionals and is our most competitively priced range.

ES Estas populares series son bien recibidas tanto por particulares como profesionales, siendo nuestra gama más económica y competitiva.



some key features:

- doorway without threshold;
- profile 50x50 mm;
- tube 22 mm;
- very strong rail profile 55x65 mm;
- board thickness 32 mm;
- board height 1200 mm.



Standard version



- hot-dip-galvanized: NEN-EN-ISO 1461;
- width: 3000, 3500 mm;
- sliding door;
- boards type: plastic;
- boards height: 1200 mm.

Plastic boards



Additional options



- powder coated;
- boards type: bamboo or oak;
- small window in the door.

Wooden boards

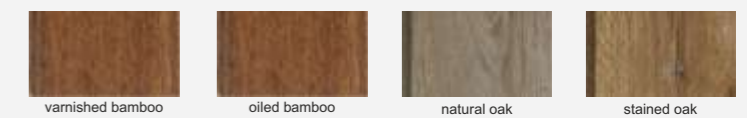

Professional-Series

Some **HORSES** have all the luck !!

THE SERIES SUITABLE FOR ALL HORSES

Professional Series

- NL Vanaf 2016 voorzien van ons nieuwe opd. profiel met een ronde bovenzijde voor extra uitstraling van uw stal.
- GB Improved in 2016 with our new, very attractive, rounded channel section. This range is suitable for all horses, providing a safe and functional environment.
- ES Mejorada en 2016 con nuestra nueva y atractiva sección redondeada. Esta gama es adecuada para todo tipo de caballos, procurando un entorno seguro y funcional.

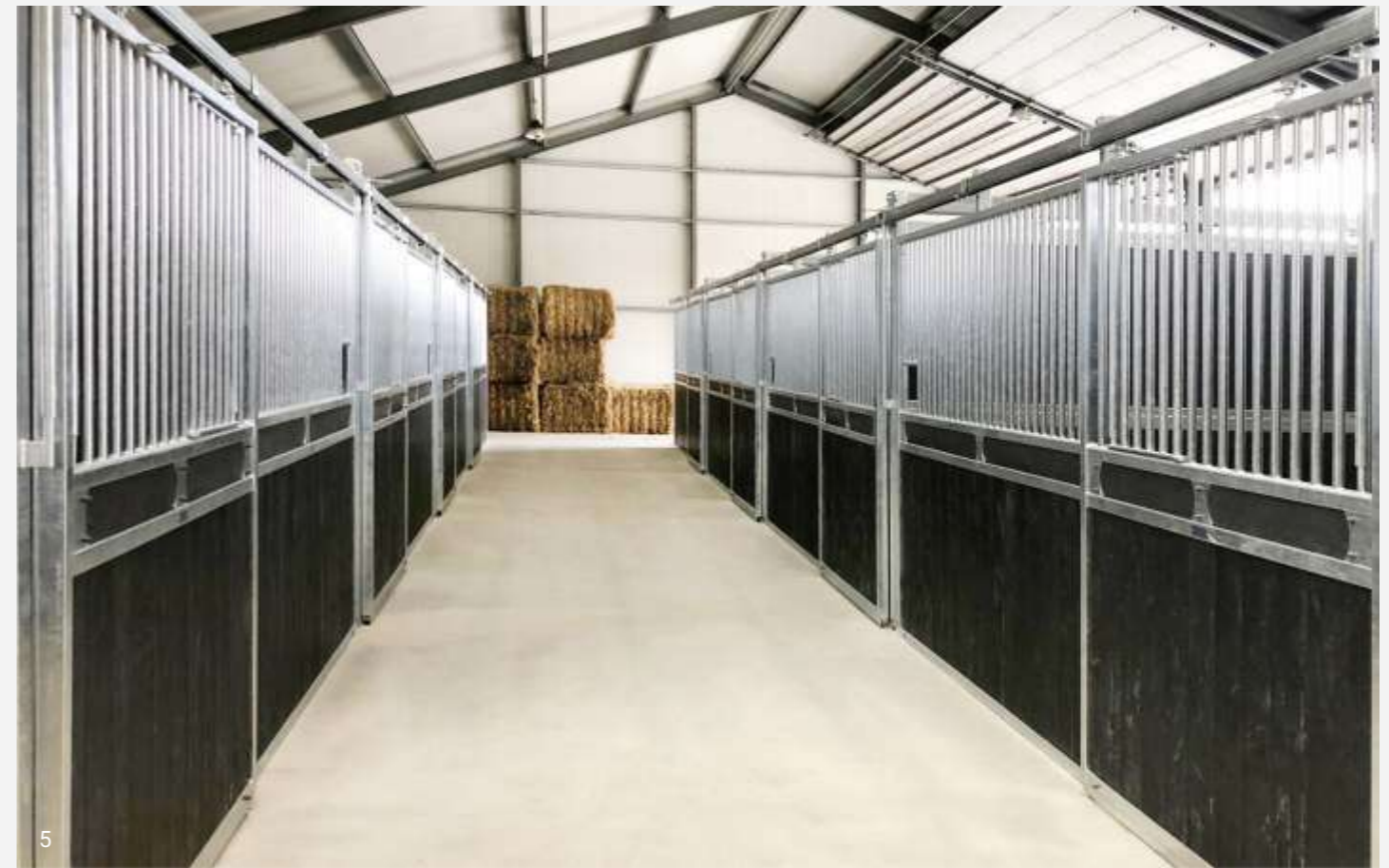

some key features:

- doorway without threshold;
- profile 60x60 mm / 60x40 mm;
- tube 26,9 mm;
- very strong rail profile 55x65 mm;
- board thickness 32 mm;
- board height 1300 mm.



Standard version



- hot-dip-galvanized: NEN-EN-ISO 1461;
- width: 3000, 3500, 4000 mm;
- sliding door;
- boards type: plastic;
- boards height: 1300 mm.

Plastic boards



Additional options



- powder coated;
- boards type: bamboo or oak;
- horizontal board: on top/on bottom;
- small window in the door.

Wooden boards

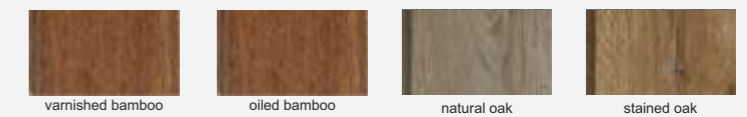

Arched Professional-Series

(version with additional options)

Some **HORSES** have all the luck !!

Young horses

Some HORSES have all the luck !!



FOR FOALS AND YOUNG HORSES

Young horses

NL

Variabele eetopeningen dmv. een inzet-spijl van 48 mm zo kan de breedte van de eetopeningen aangepast worden aan het paard. Met deze optie kan de veiligheid voor het paard nog meer vergroot worden.

GB

This European feeding front has adjustable width head spaces to accommodate all breeds. This provides additional safety.

ES

Este frontal para acceso a alimentación, tiene anchos de cabeza ajustables para acomodar a cualquier raza, proporcionando una seguridad adicional.



A SERIES OF WAVE TYPE STABLES

Royal Wave

NL

Het senior model uit onze reeks van "Waves" een wand met een Koninklijke uitstraling. Vanaf 2016 voorzien van ons nieuwe opd. profiel met een ronde bovenzijde voor extra uitstraling van uw stal.

Plank dikte **32 mm** / Plankhoogte **1300 mm**.

GB

The oldest in our range of low fronted stables, with a regal look. Since 2016 we have produced this range with our new rounded channel to give an even more attractive appearance.

Board thickness **32 mm** / Board height **1300 mm**.

ES

El más antiguo de nuestros frontales bajos, con un look majestuoso. Desde 2016 producimos este frontal con nuestro nuevo acabado de perfiles redondeado que le confieren una apariencia aún más atractiva. Grosor de las tablas **32 mm** / Altura de las tablas **1300 mm**.



Standard version



- hot-dip-galvanized: NEN-EN-ISO 1461;
- width: 3000, 3500, 4000 mm;
- hinged door;
- boards type: plastic;
- horizontal board on top;
- boards height: 1300 mm.

Plastic boards



Additional options



- powder coated;
- boards type: bamboo or oak;
- horizontal board: on bottom;
- ornamental plates or balls;
- cross in the door;
- openwork boards.

Wooden boards

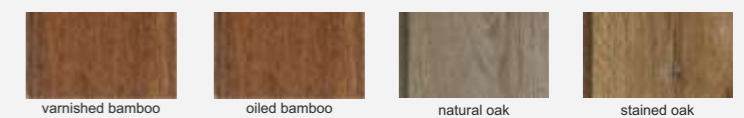

Classic-Wave

Some **HORSES** have all the luck !!

A SERIES OF WAVE TYPE STABLES

Classic Wave

NL

Een rond gewalste Wave, stijlvol en klassiek.
Vanaf 2016 voorzien van ons nieuwe opd. profiel met een ronde bovenzijde voor extra uitstraling van uw stal.
Plank dikte **32 mm** / Plankhoogte **1300 mm**.

GB

Another of our 'Wave' range.
The lines of this design create a stylish and classic look. Since 2016 we have produced this range with our new rounded channel to give a more attractive appearance.
Board thickness **32 mm** / Board height **1300 mm**.

ES

Otro de nuestros modelos "Ondulados".
Las líneas de este diseño ofrecen un look clásico y con estilo. Desde 2016 producimos este modelo con nuestro acabado de perfiles redondeados que le confieren una apariencia aún más atractiva.
Grosor de las tablas **32 mm** / Altura de las tablas **1300 mm**.



Standard version



- hot-dip-galvanized: NEN-EN-ISO 1461;
- width: 3000, 3500, 4000 mm;
- hinged door;
- boards type: plastic;
- horizontal board on top;
- boards height: 1300 mm.

Plastic boards



Additional options



- powder coated;
- boards type: bamboo or oak;
- horizontal board: on bottom;
- ornamental plates or balls;
- cross in the door;
- openwork boards.

Wooden boards

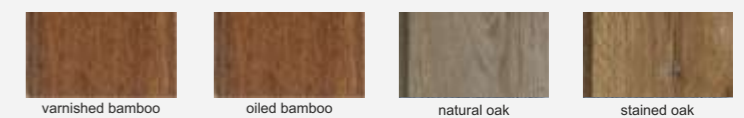

Canterbury

Some **HORSES** have all the luck !!

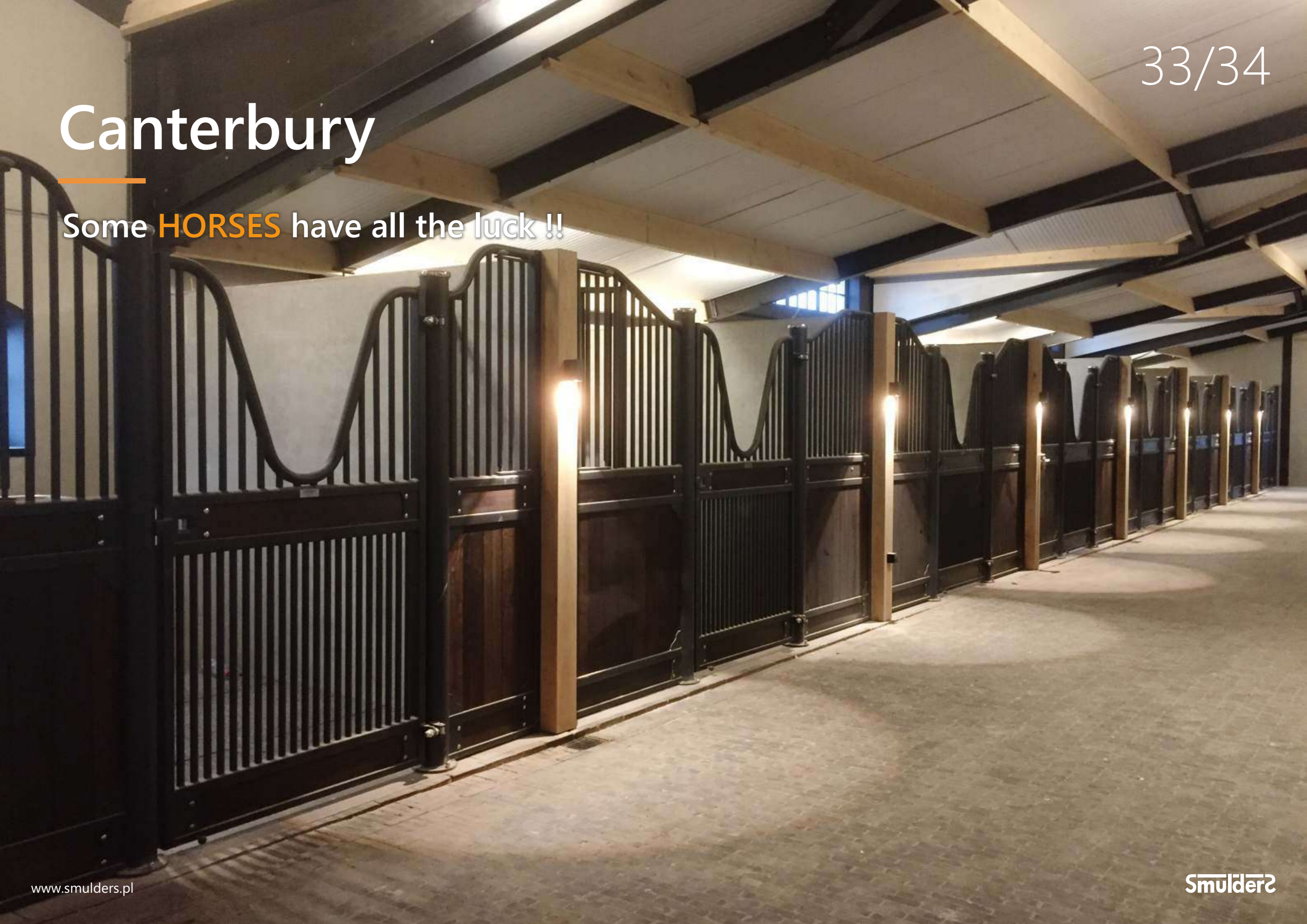

A SERIES OF WAVE TYPE STABLES

Swing Wave

NL

Het nieuwste model uit onze reeks van "Waves" een wand met een Keizerlijk uitstraling. Vanaf 2016 voorzien van ons nieuwe opd. profiel met een ronde bovenzijde voor extra uitstraling van uw stal. Uniek concept een open luxe wand die ook volledig opendraaibaar is.

Plank dikte **32 mm** / Plankhoogte **1300 mm**.

GB

The most recent in our 'Wave' range. The Swing Wave offers an interesting alternative look. Since 2016 we have produced this range with our new rounded channel to give an even more attractive appearance.

Board thickness **32 mm** / Board height **1300 mm**.

ES

El modelo más reciente de nuestra gama "Ondulada". El Swing Wave ofrece un look interesante y alternativo. Desde 2016 producimos este modelo con nuestro acabado de perfiles redondeados que le confieren una apariencia aún más atractiva.

Grosor de las tablas **32 mm** / Altura de las tablas **1300 mm**.



options:

- stainless steel tubes;
- extra horizontal board;
- bamboo boards;
- stainless steel hinges;
- powder coated;
- bamboo cross in the door;
- ornamental ball or plate.



Windsor

Some **HORSES** have all the luck !!

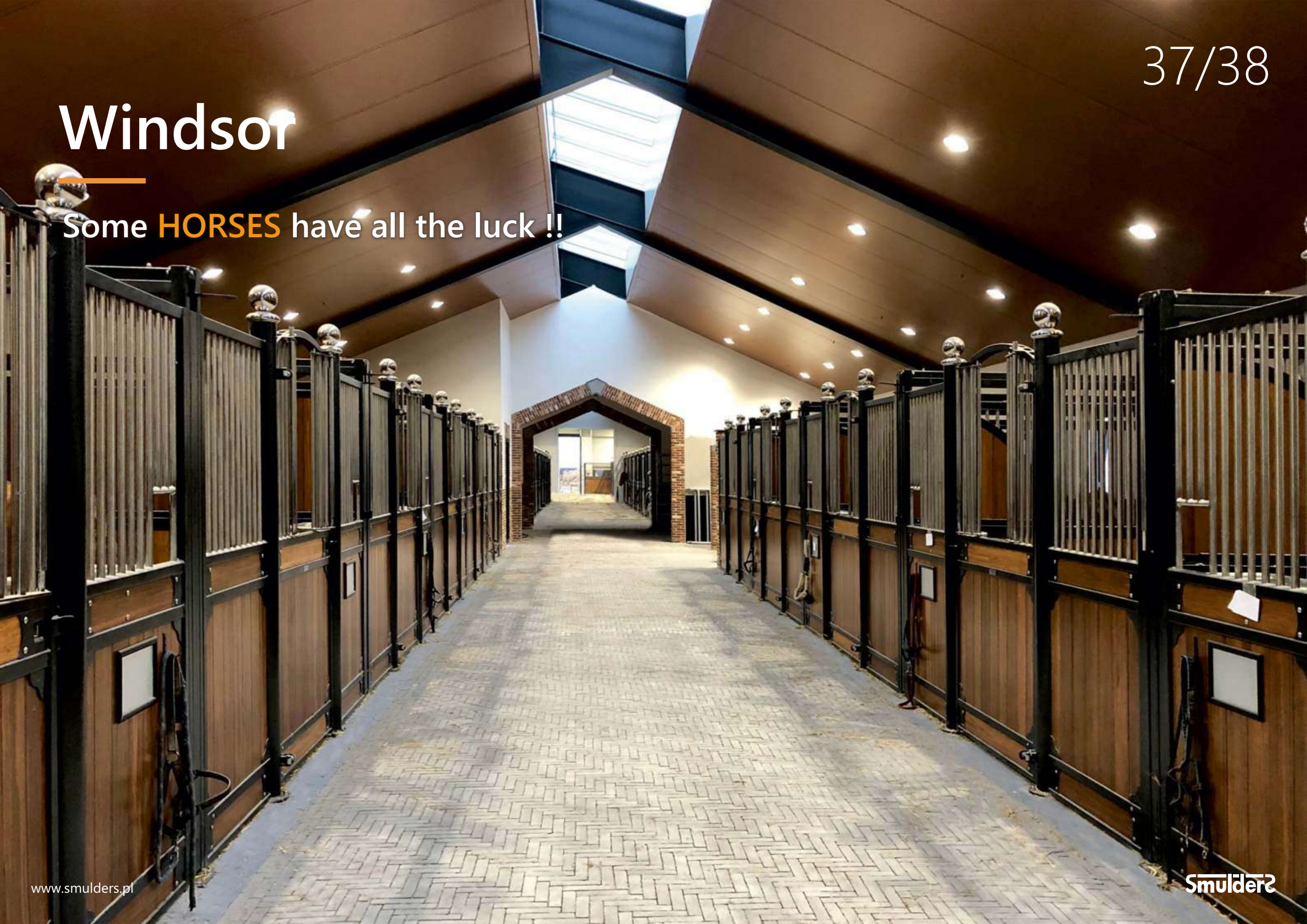



THE MOST POPULAR OF LUXURY FRONTS

Windsor

Windsor is the most popular in our range of luxury stable fronts. A true classic. This front can be customized to suit your specific requirements.



Stables Windsor

De bestseller uit onze reeks van luxe wanden.

Een echte klassieker. Een wand die geheel naar eigen wens kan worden samengesteld.

NL

Vanaf 2016 voorzien van ons nieuwe opd. profiel met een ronde bovenzijde voor extra uitstraling van uw stal. Plank dikte **32 mm** / Plankhoogte **1300 mm**.

The Windsor is the most popular in our range of luxury stable fronts. A true classic. This front can be customized to suit your specific requirements.

GB

Board thickness **32 mm** / Board height **1300 mm**.

El Windsor es el modelo más popular de nuestro rango de frontales de lujo. Un verdadero clásico. Este frontal puede adaptarse para satisfacer sus requisitos específicos.

ES

Grosor de las tablas **32 mm** / Altura de las tablas **1300 mm**.



Standard version



- hot-dip-galvanized: NEN-EN-ISO 1461;
- width: 3000, 3500, 4000 mm;
- hinged door;
- boards type: plastic;
- horizontal board on top;
- boards height: 1300 mm.

Plastic boards



Additional options



- powder coated;
- boards type: bamboo or oak;
- horizontal board: on bottom;
- ornamental plates or balls;
- cross in the door;
- openwork boards.

Wooden boards

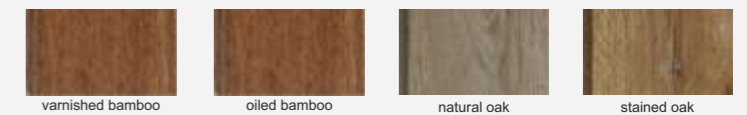

WINDSOR

COMPLETELY CONSTRUCTED
FROM STAINLESS STEEL

Some **HORSES** have all the luck !!

Grand Prestige

Some **HORSES** have all the luck !!

A STYLE THAT REFLECTS THE PAST

Grand Prestige

*"We have been making
this range since 2015"*

NL

Een wand die het verleden doet herleven, echter wel met het hedendaagse comfort.
Plank dikte **32 mm** tot **52 mm** / Plankhoogte **1300 mm**.

GB

A style which reflects the past brought up to date with high quality modern materials.
Board thickness **32 mm** to **52 mm** / Board height **1300 mm**.

ES

Un estilo que refleja la belleza del pasado traído al presente con materiales modernos de calidad superior.
Grosor de las tablas **32 mm** a **52 mm** / Altura de las tablas **1300 mm**.



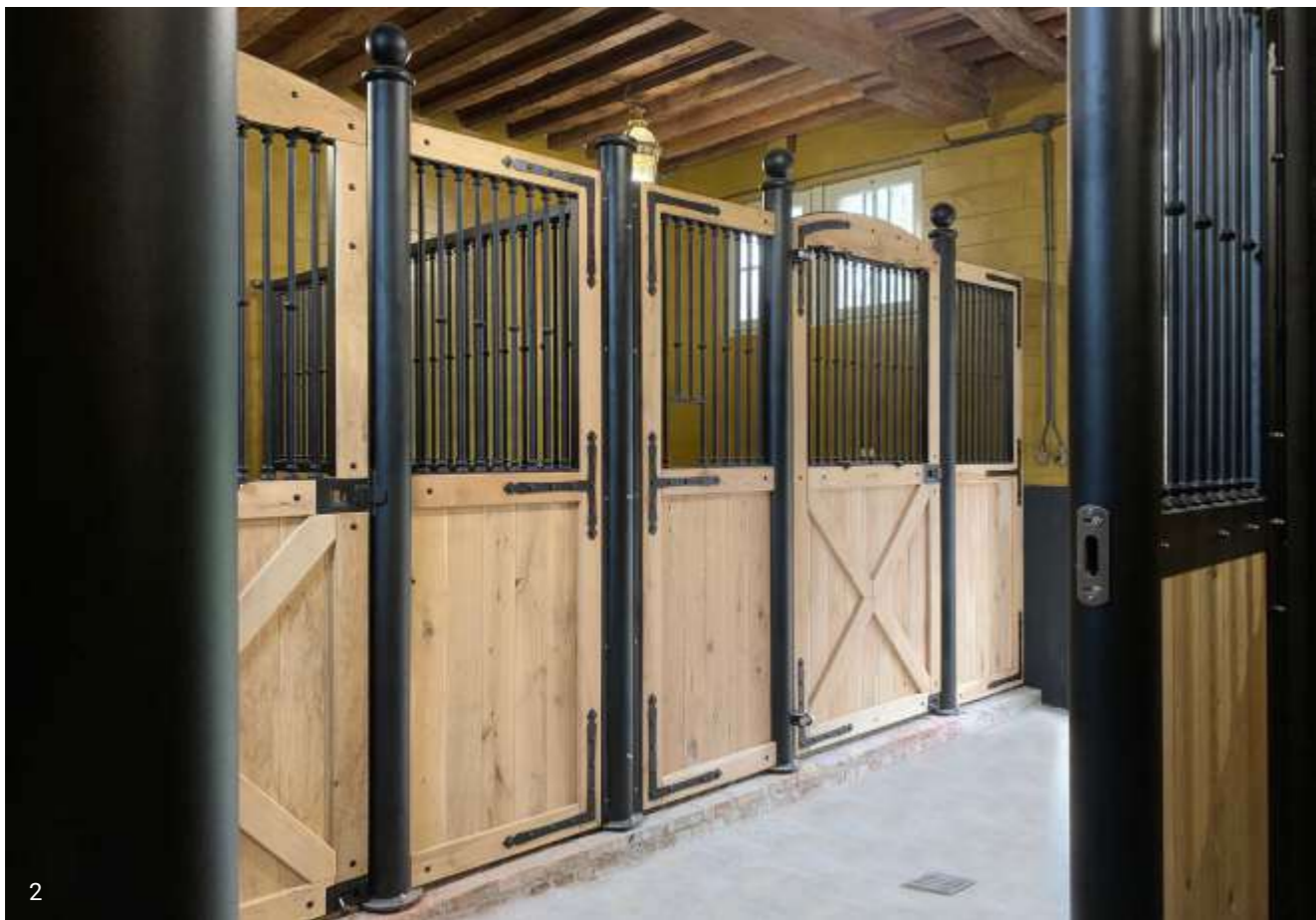

Partition walls

Some **HORSES** have all the luck !!



Partition walls

We offer a great selection of partition walls for horses. Partition walls with a full grille top, partition walls with a 2/3 grille and privacy panel and solid stall partition walls.

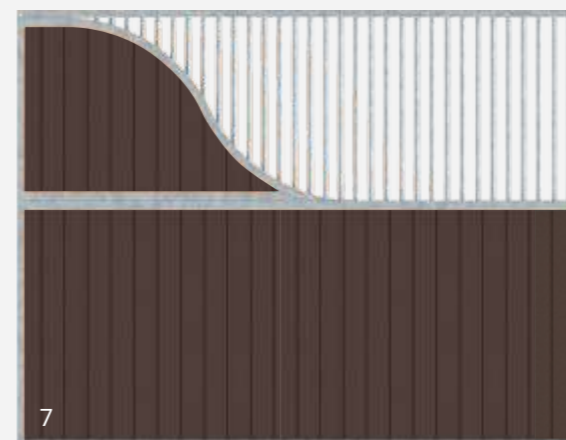
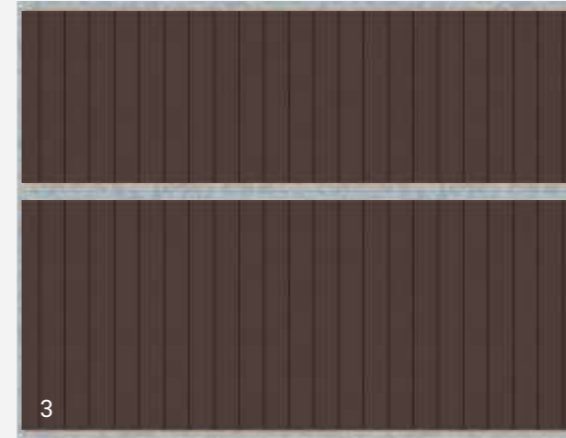

AN ALTERNATIVE SOLUTION FOR TRADITIONAL STABLES

Outdoor stables

Onze buitenboxen zijn leverbaar in vele verschillende soorten en maten.

NL

- Zadeldak.
- Lessenaarsdak.
- Kunststof / Bamboe.
- Alleen verzinkt of verzinkt en gecoat.

Our outdoor stables are available in many different types and sizes.

GB

- Apex roof.
- Pent roof.
- Plastic / Bamboo.
- Only galvanized or galvanized and powder coated.

Nuestros Boxes de exterior están disponibles en distintos estilos y medidas.

ES

- A un agua.
- A dos aguas.
- Plástico / Bambú / Madera Tropical.
- Solo galvanizado o galvanizado + pintado al. horno.



AN ALTERNATIVE SOLUTION FOR TRADITIONAL STABLES

American barns

NL Ook het complete gebouw incl. binnenboxen kan door ons verzorgd worden. **Belangrijk:** montage op een betonnen vloer / fundament dat **minimaal** afloopt naar buiten. Wanneer u voor het aanleggen van de betonnen vloer / fundament contact met ons opneemt zorgen wij voor het fundament-plan.

GB We can supply the entire building, complete with internal stables. All you need to do is provide a concrete foundation and floor to the specifications on our floor plan.

ES Podemos suministrar el edificio completo, incluyendo todos los boxes de interior, o libre y diáfano para otros usos. Todo lo que necesita es una base de hormigón llana siguiendo las especificaciones de nuestro plano de planta.



Windows

Some **HORSES** have all the luck !!



OUR ATTENTION TO DETAIL MAKES THE DIFFERENCE



Windows

Het kleine detail maakt het verschil!

NL

- Kozijnen met afgeronde hoeken.
- RVS sluitknop.
- Standaard veiligheidsglas 3/0,5/3.
- Bij gecoate ramen RVS scharnieren.

Our attention to detail makes the difference!

GB

- Frames without sharp edges.
- Lockable stainless steel doorknob.
- Standard safety glass 3/0,5/3.
- Coated windows with stainless steel hinges.

Nuestro cuidado y atención por los detalles marca la diferencia!

ES

- Marcos sin cantos vivos.
- Manetas con cierre en acero inoxidable.
- Cristales de seguridad estándar 3/0,5/3.
- Ventanas pintadas al horno con bisagras en acero inoxidable.





Closed windows

The boards

- plastic - colours available: brown, black, green, beige, grey, brick red - 32 mm thick (thick tongue and groove boards);
- bamboo in the same specification.



Safety glass windows

- safety glass: 3/0,5/3 mm;
- tube diameter: 22 mm;
- tilt & turn window.



Arched windows

- safety glass: 3/0,5/3 mm;
- tube diameter: 22 mm;
- tilt & turn window.



Doors

67/68

Some **HORSES** have all the luck !!



OUR ATTENTION TO DETAIL MAKES THE DIFFERENCE



Doors

Ook bij de deuren gaat het om het detail, het is het kleine detail dat de deur maakt!

NL

- Kozijnen met afgeronde hoeken.
- RVS sluitknop, RVS twee-vinger slot, ook te openen van binnen.
- Standaard veiligheidsglas 3/0,5/3.
- Bij gecoate ramen RVS scharnieren.

Again, it is our attention to detail which makes all the difference to our comprehensive range of doors.

GB

- All around the frame there are no sharp edges as the angle frame is rounded.
- Lockable stainless steel doorknob.
- Stainless steel two-finger lock which can be opened from the inside or out.
- Standard safety glass 3/0.5/3.
- Coated windows with stainless steel hinges.

De nuevo, es nuestra atención a los detalles es lo que marca la diferencia en todo nuestro amplio abanico de puertas.

ES

- Sin cantos vivos en todo el marco de la puerta, gracias a los perfiles edondeados.
- Manetas con cierre en acero inoxidable.
- Cierre de dedo en acero inoxidable con apertura interior y exterior.
- Cristal de seguridad estándar 3/0.5/3.
- Ventanas pintadas al horno con bisagras en acero inoxidable.





Double door fully closed

The boards

- plastic - colours available: brown, black, green, beige, grey, brick red - 32 mm thick (thick tongue and groove boards);
- bamboo in the same specification;
- coated door with stainless steel hinges.



Double door with safety glass

- safety glass: 3/0,5/3 mm;
- tube diameter: 22 mm;
- tilt & turn window.
- coated door with stainless steel hinges.



Arched double door with safety glass

- safety glass: 3/0,5/3 mm;
- tube diameter: 22 mm;
- tilt & turn window.
- coated door with stainless steel hinges.

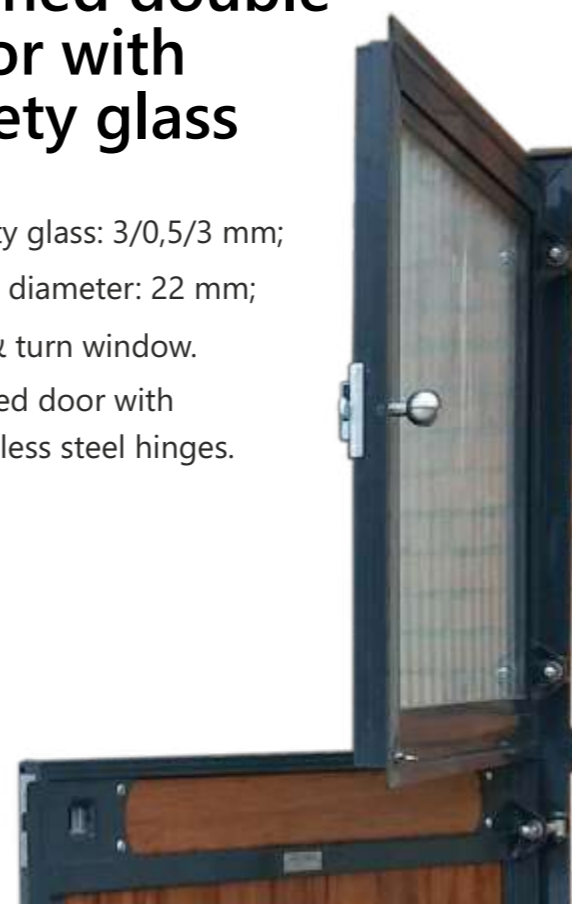
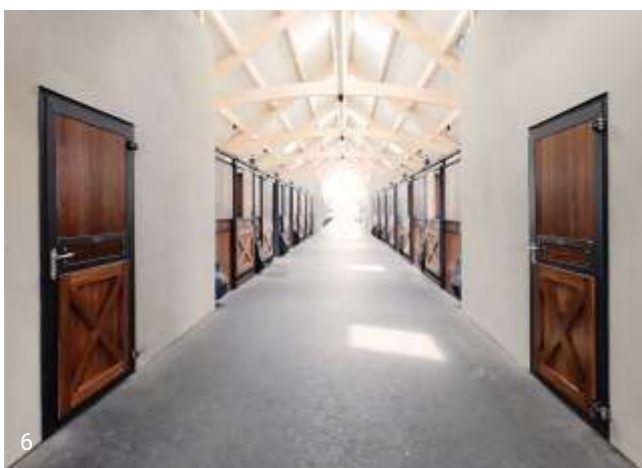

Barn doors

Some **HORSES** have all the luck !!



HINGED AND SLIDING DOORS

Barn doors

Een kroon op uw gebouw, het detail dat het gebouw doet stralen.

NL

- Kozijnen met afgeronde hoeken.
- RVS en Alu. sluitwerk.
- Standaard veiligheidsglas 3/0,5/3.
- Bij gecoate ramen RVS scharnieren.

Our doors will greatly enhance the external appearance of your building.

GB

- All around the frame there are no sharp edges as the angle frame is rounded.
- Stainless hinges and aluminium locks.
- Standard safety glass 3/0.5/3.
- Powder coated doors with stainless steel hinges.

Nuestras puertas aportarán una inmejorable apariencia externa de su edificio. De 2 o 4 piezas, correderas o batientes.

ES

- Sin cantos vivos en todo el marco de la puerta, gracias a los perfiles redondeados.
- Cierres en aluminio o acero inoxidable.
- Cristal de seguridad estándar 3/0.5/3.
- Ventanas pintadas al horno con bisagras en acero inoxidable.



Hinged doors

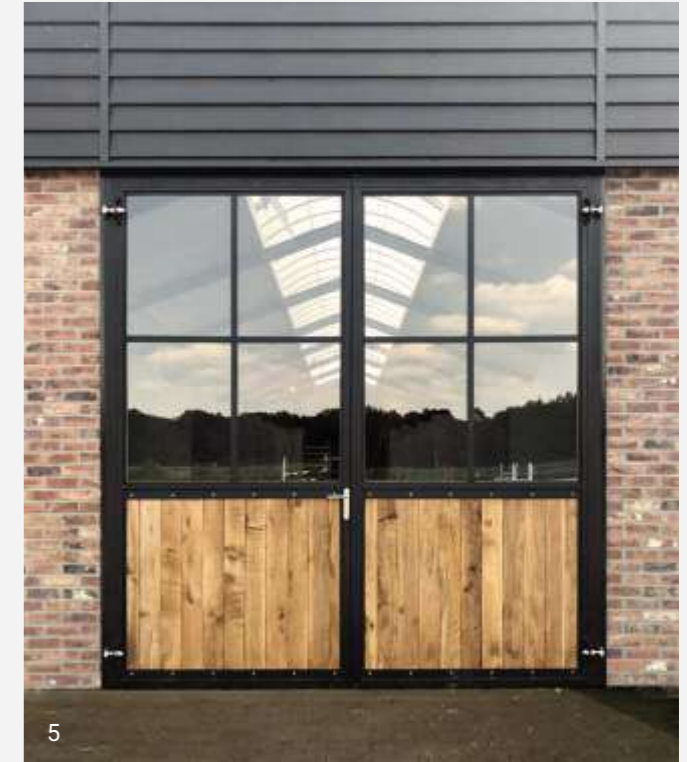

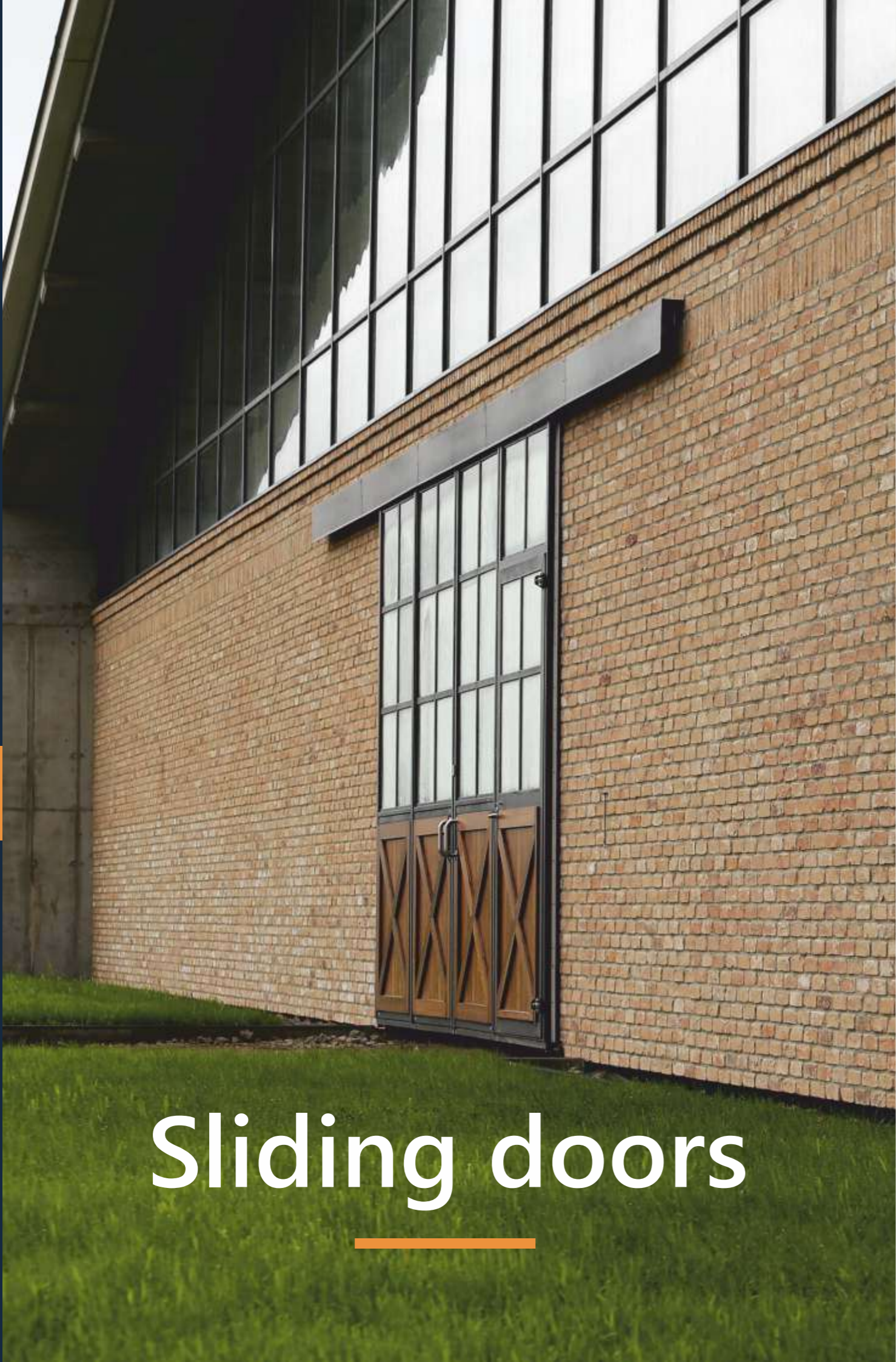

Sliding doors



WE OFFER 3 AND 4 PANEL SOLARIUMS

Horse solariums

NL

Een zeer solide behuizing die door de open constructie de vochtdampeneenvoudig kan afvoeren, hierdoor kan er geen hinder ontstaan aan de infrarood werking. Frisse lucht wordt aan de achterzijde aangezogen en bij de lampen richting het paard geblazen, zodoende wordt de warmte goed verdeeld.

GB

A very solid construction. Due to the open construction of the solarium the moisture given off from the horse is dispersed, so that the efficient working of the infra-red lamps is maintained. Fresh air is sucked in at the rear, allowing an equal distribution of warmth around the horse.

ES

Una estructura sólida. Dada la apertura de su diseño, facilita que la humedad del caballo se disipe fácilmente y la función de las luces infra-rojas se mantenga. El aire fresco es succionado por la parte trasera, permitiendo una distribución equilibrada del calor alrededor del caballo.



We offer 3 and 4 panel solariums in attractive prices. Our solariums are characterized by a simple construction and easy attendance. They are equipped with fans which force the appropriate air circulation that prolong lamps' life and what is more, it makes the drying process much faster for the horse.

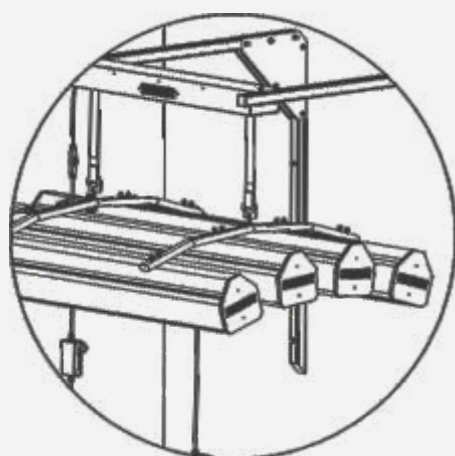

Solarium parameters

- number of heating lamps in one panel: 5
- lamps power: 150W-250W
- number of fans: 1 in each panel
- power: 2616 W (3-panels), 3088 W (4-panels)
- power voltage: 230V
- weight: 3-panels: 49 kg, 4-panels: 61 kg

WASH STALLS, TIE POSTS, TIE RINGS, SHOWER SETS...

Around the solarium



Accessories



① Wash stall



② Tie post



③ Tie ring



④ Horse feeder 1



⑤ Horse feeder 2



⑥ Hay rack



⑦ Veterinary 1



⑧ Veterinary 2

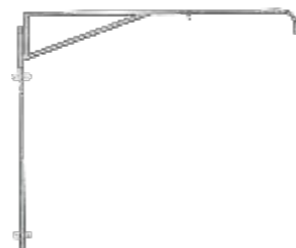

⑨ Shower set



⑩ Feed trolley



⑪ Drinking bowl



⑫ Protection brackets for drinking bowl



1

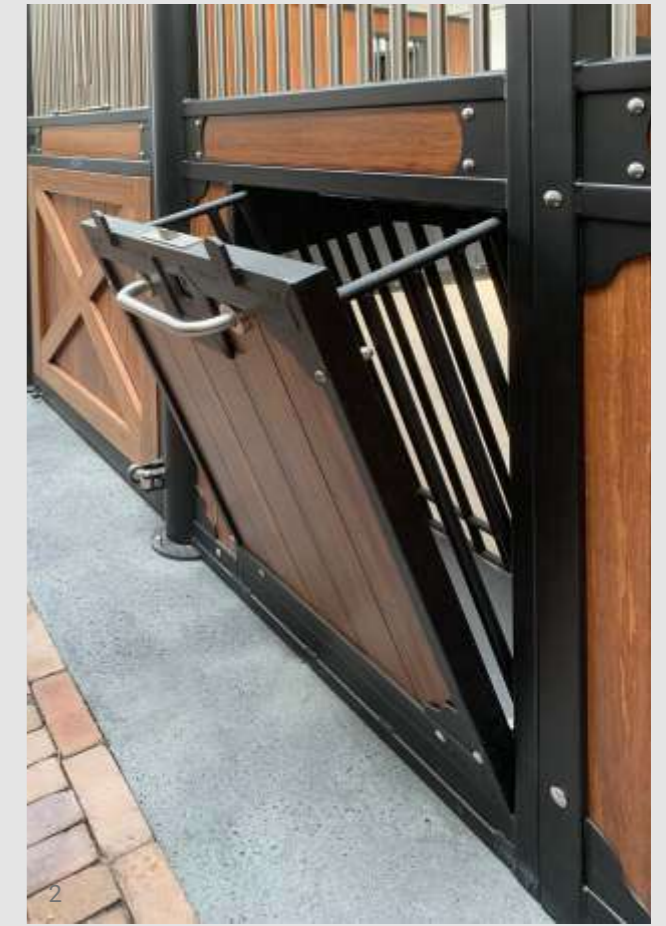

2



3

The Shimon hay bucket

THE PERFECT DEVICE THAT EXERCISES YOUR HORSES

Horse walkers and roofs

NL

Onze trainingsmolen is oerdegelijk, probleemloos en zeer concurrerend geprijsd. Standaard geleverd met gesloten tafel en sierlijk paardenhoofd op de toren. De motor zit onder de tafel en achter beschermkappen, dit voor extra veiligheid.

GB

Our horse walker is extremely solid, trouble free and competitively priced. Our standard model is supplied with an attractive horse's head to cap the centre post. The engine is mounted under the table, surrounded by protective covers, providing extra safety.

ES

Nuestro caminador es extremadamente robusto, sin ninguna complicación y a un precio muy competitivo. Nuestro modelo estándar se entrega con una atractiva decoración de cabeza de caballo en el poste central. El motor se ubica dentro de la caja, protegida por una cubierta adicional que proporciona una seguridad adicional. Opción: Sin cubierta, con cubierta parcial o total.

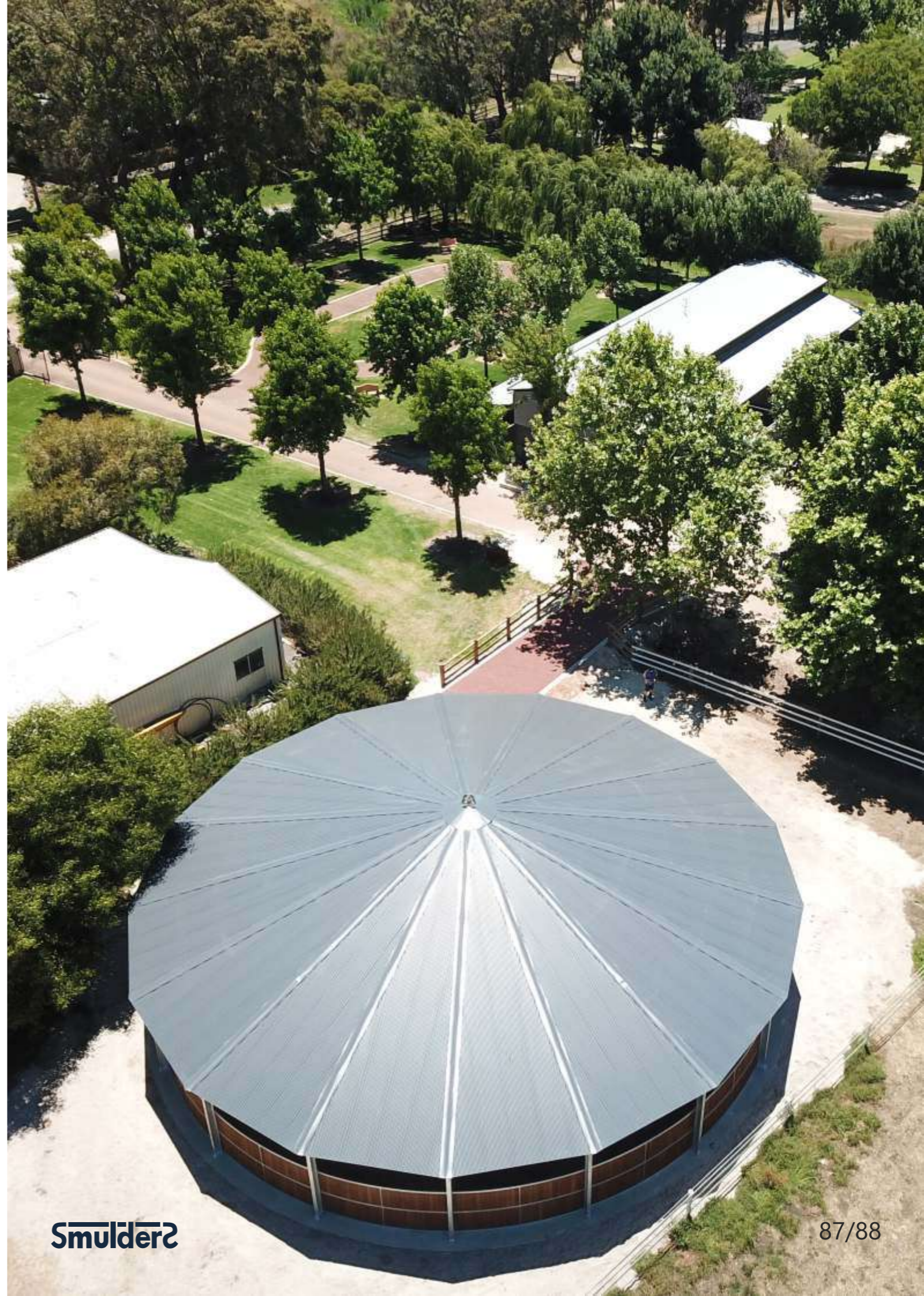



HORSE WALKERS & ROOFS

Open roofing

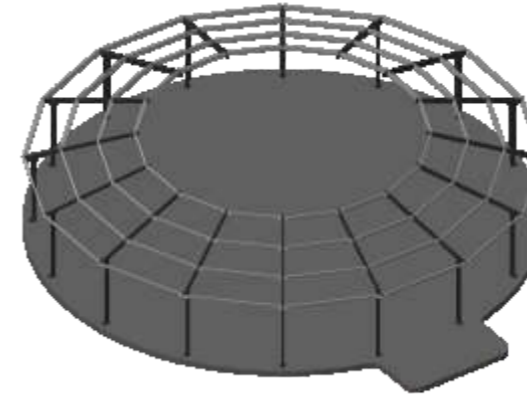

Dimensions:

- 12 meters;
- 15 meters;
- 16 meters;
- 18 meters;
- 20 meters.

Closed roofing

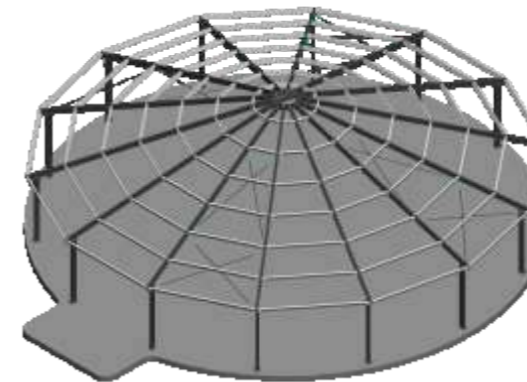

CONTACT



SPRZEDAŻ W POLSCE

Mr. Dariusz Wajs

ul.Grodziska 17 B
62-067 Rakoniewice
Tel.: +48 614441405
Mobile: +48 668823832
E-mail: dwajs@smulders.pl
www.smulders.pl

VERKOOP ADVISEUR
BENELUX / DUTSLAND**Dhr. Marco Brons**

Hulsenboschstraat 37
4251 LR Werkendam
Mobile: +31 651304171
E-mail: info@smulders.pl
www.smulderspaardenboxen.nl



REPRÉSENTANT FRANCE / SUISSE

M. Etienne Proust

PROUST sarl
4 rue Salvador Allende
63200 Riom
Mobile: +33 677538878
E-mail: etienne@proust.fr
www.proust.fr



REPRESENTANTE ESPAÑA

Mr. Joan Humet

Company EQUUS LIFE SL
Autopista AP7 salida 18 Ctra. B140
de Sabadell a Mollet km 5,15 – NAVE nº 5
Santa Perpétua de Mogoda Barcelona 08130
Tel.: +34 931123940
E-mail: info@equus-life.com
www.equus-life.com
www.smulders.es

REPRESENTATIVE
AUSTRALIA / NEW ZEALAND**Mr. Charlie Hay**

Company KILLAHY EQUINE
PO Box 133 Marrickville NSW 1475
Tel.: +61 2 9138 0696
Mobile: +61 400522330
E-mail: charlie.hay@killahyequine.com.au
www.killahyequine.com.au



REPRESENTATIVE USA

Mr. Bart Kenis

Barnwalkers, LLC
1902 South Club Dr.
Wellington, FL 33414
Mobile: +1 561-568 2295
bart@barnwalkers.com
www.barnwalkers.com



REPRESENTATIVE UK / IRELAND

Mr. Roger Buck

Company ROGER BUCK 'EQUINE DESIGN'
Space at the Quay Fen Lane, Beccles
NR34 9BH
Mobile: +44 7341448624
E-mail: roger@smulders.co.uk
www.smulders.co.uk



REPRESENTANTE PORTUGAL

Mrs. Celia Marques

Celicerca-Vedações e Serviços Equestres Lda
Rua da Indústria
Zona Industrial Vilar dos Prazeres
2490-802 Ourém
Tel.: +351 249095284
Mobile: +351 916334347
E-mail: geral@celicerca.com
www.celicerca.com



REPRESENTATIVT SVERIGE

Mr. Hans Tuvehjelm

Company City-Boxen International AB
Televägen 2, 291 62 Kristianstad
Tel.: +46 44204440
Mobile: +46 706298930
E-mail: hans@city-boxen.se
www.city-boxen.se



REPRESENTATIVE UK / IRELAND

Mr. Dariusz Wajs

ul.Grodziska 17 B
62-067 Rakoniewice
Tel.: +48 614441405
Mobile: +48 668823832
E-mail: dwajs@smulders.pl
www.smulders.pl



VERTRETER DEUTSCHLAND

Mr. Tomas Fischer

Fischer Stalltechnik GmbH
Tel.: +49 251 92436940
fischer@fischer-stalltechnik.com
www.fischer-stalltechnik.com



REPRESENTATIVT SVERIGE

Mr. Robert de Rover

Robert de Rover Ridsport AB
Hönsholma 126
284 91 Perstorp
Mobile: +46 730890459
E-mail: info@robertderover.com
www.robertderover.se



נציג בישראל

מר שלי שדות

חברת שליוד בע"מ
גן יאשיה 3885000
נייד: 050-5944781
shaliwood68@gmail.com



ممثل الامارات العربية المتحدة

Al Saheel General TR

Maysaloun
Sharjah
23109 Sharjah
TRN:100297458000003
Mobile: +971 55 668 3424
Mobile: +971 56 588 8990
alsaeel@alsaeel.co



RAPPRESENTANTE ITALIA

Mrs. Maria Pia De Caro Fioravanti

via Palermo 52-00055 Ladispoli (Rome) IT
Tel.: +39 069946948
Mobile: +39 3386381455
E-mail: mariapiadecaro@gmail.com



RAPPRESENTANT MALTA

Mr. Karl Debono

Company: Debono Trading
Tel.: +35 699451568
krl.debono@gmail.com



REPRESENTATIVE GREECE

Mr. Dimitris Koukoulis

Company: EQUILAND SPORTS
Elyth 4 Nea Redestos
Thessaloniki 57001
Mobile: +30 6944595981
E-mail: equiland@yahoo.gr